



Divan de dermatologie
Gamme OVALIA Version 2
OV2-85-125

CARINA
Medical



CE
ISO 9001
ISO 13485

DESCRIPTION TECHNIQUE

- Divan de dermatologie à hauteur variable électrique, 2 parties
- Commande : Télécommande manuelle multifonctions
- Réglage du dossier en toutes positions par vérin électrique
- Position Déclive/Proclive en standard
- Sellerie tendue plate de bonne densité 24kg/cm², non-feu classée M1, épaisseur 5cm
- Châssis composé de 2 colonnes télescopiques pour une grande stabilité du divan
- Equipé d'une tête réglable en hauteur et inclinable spécialement adaptée pour les soins du visage et idéale pour les soins du dos
- Piètement carterisé pour une hygiène optimale, coloris gris clair (RAL 7035)
- Sur 4 roulettes diam. 125mm avec freins

DIMENSIONS

- Largeur 70cm
- Hauteur variable de 48 à 88cm
- Capacité de charge : 200kg en dynamique

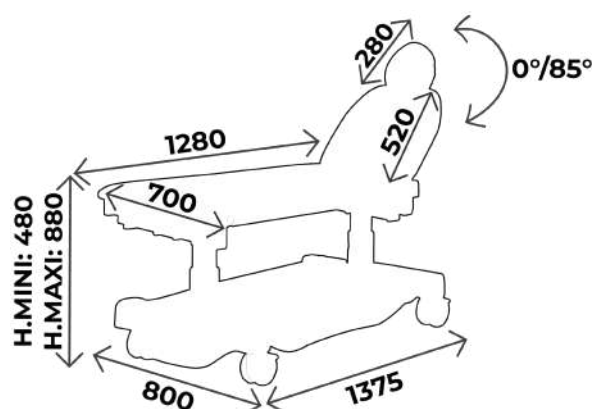

Vous aimerez aussi :

Réf. **OV2-86-125** : Idem OV2-85-125
mais commande par pédale multifonctions



À SAVOIR

- ✓ Délai : 15 jours à réception commande
- ✓ Garantie : 5 ans (1 an pour la sellerie)

ACCESSOIRES



RL-150
4 roulettes diam. 150mm
Freinage centralisé



ACC 76-OVALIA-70
Jeu d'étaux
Pour divan largeur 70cm



ACC 110POLY
Gouttière prise de sang
polyuréthane avec ferrure
Sans étau, l'unité



ACC 110
Gouttière prise de sang
Avec ferrure, sans étau, l'unité



ACC 964
Jeu de repose jambes noir,
sur rotule mousse polyuréthane,
diam. 14mm, sans étau



ACC 105
Jeu d'étriers inox standard
diam. 14mm, sans étau



SLFEMIREPOSE
Housse prélude pour repose
jambes (ACC964), l'unité



ACC 514-UNIVERSE
Protection plastique transparent
universelle



ACC 32012
Tige porte-sérum diam. 16mm
2 crochets plastiques, sans étau



ACC 76C
Etau unitaire
pour tige porte-sérum diam. 16mm



ACC 832
Trou visage avec bouchon



ACC 54002
Tête 1/2 Lune largeur 70cm
Revêtement non feu M1



ACC OVALIA06
Télécommande manuelle OVALIA
+ Cordon Y (double commande)



ACC OVALIA05
Pédale multifonctions OVALIA
+ Cordon Y (double commande)



ACC OVALIA02
Paire rails inox 25x10
long. 1500mm
Pour OVALIA 2 parties



ACC BATTERIE01
Batterie autonomie de 20 cycles
(1 cycle = une montée/ descente
+ une montée/ descente
de dossier)



ACC BARRILITOV02
Paire de barrières escamotables
Pour divan largeur 70cm



ACC TETERGO
Tête ergonomique amovible



ACC-CAPOT
Peinture capot
Autre que le gris standard (7035)
16 coloris disponibles

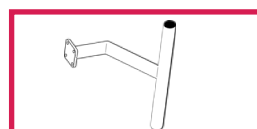

ACC FEMINA01
Support colposcope

COLORIS SELLERIE

Sellerie non-feu
classée M1

Pour les coloris de sellerie, vous avez le choix entre la gamme Classique et Urban
Attention ! coloris Urban avec plus value

Revêtement : Sellerie Gamme Classique



Arno



Garonne



Potomac



Amour



Mississippi



St Laurent

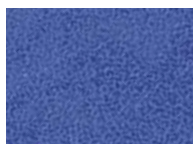

Rhône



Missouri



Seine



Amazone

Revêtement : Sellerie Gamme Urban



Abysse

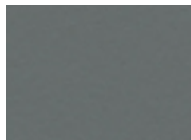

Cendre



Origan



Géranium

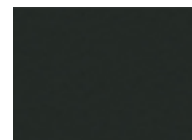

Réglisse



Prune

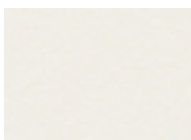

Perle

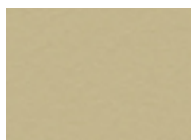

Ficelle

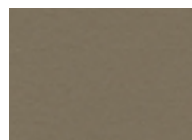

Terre

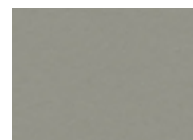

Béton

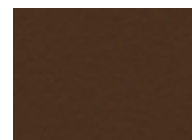

Chataigne

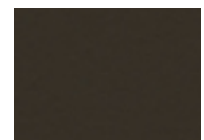

Chocolat

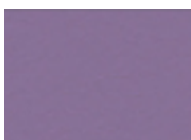

Pensée



Pétrole



Turquoise



Granny



Absinthe



Ananas



Orange



Fuschia



Tomate

COLORIS PIÈTEMENT

Toute la gamme OVALIA V2 a un capot coloris gris clair (RAL 7035) en standard
Possibilité de changer le coloris de capot **avec plus value (option ACC CAPOT)**

Piètement Peinture EPOXY



RAL 9003

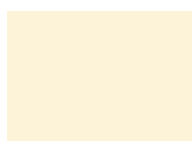

RAL 1013

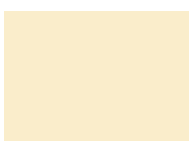

RAL 1015



RAL 6019



RAL 6033



RAL 6000



RAL 5017



RAL 5002



RAL 5000



RAL 7035



RAL 7016



RAL 9005



RAL 1018



RAL 3020



RAL 3003

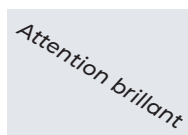

ARGENT



GUIDE D'ENTRETIEN

ENTRETIEN QUOTIDIEN

- Sellerie : nettoyage à l'eau savonneuse uniquement (solvants proscrits), peut être désinfecté avec des produits tels que Phagosept Spray, Salvanios pH10 à 0,75% et Anios Surfaces Hautes, sans matière abrasive
- Piètement : nettoyage à l'eau savonneuse uniquement (solvants proscrits) sans matière abrasive

GARANTIE

- Châssis : 5 ans
- Sellerie : 1 an



CONTACT

CARINA
Médical

Parc d'entreprises Visionis
278 rue de l'industrie
01090 GUÉREINS- FRANCE

SERVICE COMMERCIAL

Tél : +33(0)4 74 66 69 49
Fax : +33(0)4 74 66 69 50
commercial@carinamedical.com